



Installation Guide

EasyLap™ Panel
External Cladding

EXTERIORS

Australia May 2019

Make sure your information is up to date.

When specifying or installing James Hardie™ products, ensure that you have the current technical information and guides. If in doubt, or you need more information, visit www.jameshardie.com.au or Ask James Hardie™ on 13 11 03.

CONTENTS

1	INTRODUCTION	2
	EasyLap™ panel sizes	3
	Accessories/tools supplied by James Hardie™	3
	Accessories/tools not supplied by James Hardie™	3
2	SAFE WORKING PRACTICES	4
	Warning	4
	Recommended safe working practices	4
	Storage and handling	4
3	DESIGN / FRAMING	4
	Scope	4
	Design	4
	Framing	5
4	PREPARATION AND FASTENERS	6
	Preparation	6
	Fasteners	6
	Sheet Installation	6
5	DETAILS	8
	Window Details	8
	External Corner Details	8
	Internal Corner Details	8
	Junction Details	9
6	FINISHES AND MAINTENANCE	10
	Finishes	10
	Maintenance	10
7	PRODUCT INFORMATION	10

1 INTRODUCTION

EasyLap™ panel is a strong fibre cement base sheet with a shiplap vertical joint, that is finished with a site applied roll on textured acrylic paint to create a rendered look with a subtle vertical joint.

EasyLap™ panel is used as an external wall cladding in alterations and additions and residential single and medium density dwellings where a uniform, broadwall cladding is required. Ideal for full wrap or composite construction design on either timber or steel framed homes.

If you are a specifier...

or other responsible party for a project, ensure the information in these specifications is appropriate for the application you are planning and that you undertake specific design and detailing for areas which fall outside the scope of these specifications.

If you are an installer...

Ensure that you follow the design, moisture management and associated details and material selection provided by the designer and the EasyLap™ Panel Installation Guide.

IMPORTANT NOTES





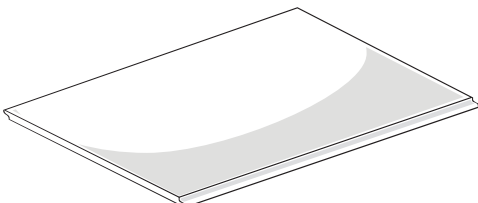

1. Failure to install, finish or maintain this product in accordance with applicable building codes, regulations, standards and James Hardie's written application instructions may lead to personal injury, affect system performance, violate local building codes, and void James Hardie's product warranty.
2. All warranties, conditions, liabilities (direct, indirect or consequential) and obligations whether arising in contract, tort or otherwise other than those specified in James Hardie's product warranty are excluded to the fullest extent allowed by law. For James Hardie's product warranty information and disclaimers about the information in this guide, visit www.jameshardie.com.au.
3. The builder must ensure the product meets aesthetic requirements before installation. James Hardie™ will not be responsible for rectifying aesthetic surface variations following installation.

EASYLAP™ PANEL SIZES (MM)

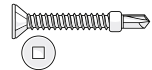
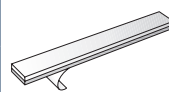
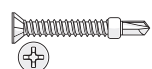
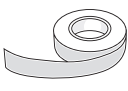
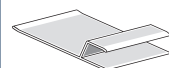
Pre-primed sheet with a ship lap edge joint along the two long edges. Sheet weighs approximately 12kg/m² in equilibrium.

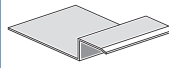
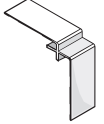
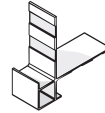

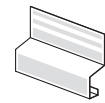



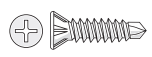

	LENGTH	WIDTH	THICKNESS	MASS (kg)
	2440	1200	8.5	36
	3000	1200	8.5	44
	3000	900	8.5	33
	3600	1200	8.5	52
	PART NO.	PRODUCT SIZES (mm)		
404186	3000 x 900			
404184	2440 x 1200			
404185	3000 x 1200			
404980	3600 x 1200			

ACCESSORIES / TOOLS SUPPLIED BY JAMES HARDIE

ACCESSORIES	DESCRIPTION	QTY	ACCESSORIES	DESCRIPTION	QTY
	HardieDrive™ Screw 41mm long A class 3 self-tapping wing-tipped screw for fastening to 0.5mm to 1.6mm BMT light gauge steel frames. Part No. 305984	1000 per box		HardieBreak™ thermal strip A building code requirement and is installed behind James Hardie™ external cladding over metal framing and HardieWrap™ weather barrier. Refer to HardieBreak™ thermal strip installation guide. Unit size 43 x 12 x 2750mm. Part No. 305612	45 per pack
	HardieDrive™ Collated Screw 41mm long A class 3 self-tapping wing-tipped screw for fastening to 0.5mm to 1.6mm BMT light gauge steel frames. Suitable for use in most auto feed screw guns. Part No. 305982	1000 per box			
	James Hardie™ 50mm wide Foam Back Sealing Tape. 25mtr long roll A self-adhesive foam tape to help improve water tightness with EasyLap™ panel and Scyon™ Axon™ cladding. It is applied under sheet joints to the HardieWrap™ weather barrier along the stud face. Part No. 304560	1 each		James Hardie™ 9mm Aluminium Horizontal h Flashing. 3,000mm long A ready to paint aluminium horizontal flashing, to be used with EasyLap™ panel and Scyon™ Axon™ cladding, for horizontal control joints. Part No. 305613	5 per pack
	James Hardie™ Joint Sealant. 300ml cartridge/600ml sausage. General purpose, paintable, exterior grade polyurethane joint sealant. Part No. 305534/305672	20 per box		James Hardie™ 9mm Aluminium Horizontal h Joints. A ready to paint aluminium horizontal jointer, used to join the James Hardie™ 9mm Aluminium Horizontal h Flashing. Part No. 305614	10 per pack
	James Hardie™ 9mm Aluminium Internal Corner. 3,000mm long A ready to paint aluminium extrusion, to be used with EasyLap™ panel and Scyon™ Axon™ cladding, at internal corner junctions to conceal the board edge. Part No. 305520	5 per pack		James Hardie™ 9mm Aluminium External Corner. 3,000mm long A ready to paint aluminium extrusion, to be used with EasyLap™ panel and Scyon™ Axon™ cladding, at external corner junctions to conceal the board edge. Part No. 305521	5 per pack
	HardieWrap™ Weather Barrier A non-perforated, highly breathable and reflective safe-glare weather barrier designed to be used behind EasyLap™ cladding to help protect the building. For alternate products, please refer to HardieWrap™ weather barrier section (p.5) Unit size 2750mm x 3000mm Part No. 305664.	1 Each		HardieEdge™ Trim An architectural slab edge solution fabricated from high-quality powder coated aluminium. Unit size: 3950mm. Part No. 305911. Also available: Base Trim Jointer 12 per pack. Part No. 305912, Internal Corner 4 per pack. Part No. 305913 and External Corner 4 per pack. Part No. 305914	4 per pack
	James Hardie™ 75x75mm Colorbond Corner Flashing. 3,000mm long A Colorbond corner flashing for use behind cladding at internal and external corners. Part No. 305564	5 per pack	TOOLS		
				HardieBlade™ Saw Blade. 185mm diameter A 185mm diameter poly-diamond blade for fast and clean cutting of James Hardie™ fibre cement. Part No. 300660	1 Each

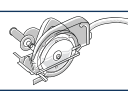
ACCESSORIES / TOOLS NOT SUPPLIED BY JAMES HARDIE

James Hardie™ recommends the following products for use in conjunction with the EasyLap™ panels. James Hardie™ does not supply these products. Please contact the component manufacturer for information on their warranties and further information on their products.

ACCESSORIES	DESCRIPTION	ACCESSORIES	DESCRIPTION
	Scrooz™ FibreFix™ 8g x 42mm 42mm long for fixing specified James Hardie™ and Scyon™ products into steel frames of 0.55mm to 0.75mm BMT. Class 3 minimum* Contact fastener manufacturer for more information.		Roll on Texture Paint EasyLap™ panels are designed to have a rolled on texture coat. Refer to Watty®, Dulux®, Taubmans® or equivalent product manufacturer, see section 6 for more information.
	Fibre cement nails 2.8 x 30mm corrosion resistant fibre cement nail for fixing EasyLap panels onto timber stud frame.		Vacuum extraction with HEPA filter Used with HEPA filter and paper bag for reduced dust exposure
	Dust-reducing saw Dust reducing saw with a HardieBlade™ saw blade. Makita 5057KB Hitachi C7YA		Gun nail A 2.8 x 40mm minimum class 3 nail with a minimum 6mm head diameter.
	Epoxy Flush Sealing (2 part) Countersunk head screws are flush filled using Megapoxy P1		ND 50mm stainless steel brad nail 14 gauge x 50mm ND 304 stainless steel nail for fixing EasyLap™ panels to a timber stud frame.

* Highly corrosive environments and areas within 1km of the coast require Class 4 or stainless steel coatings. Refer to the fastener manufacturer for recommendations.

2 SAFE WORKING PRACTICES

WARNING - DO NOT BREATHE DUST AND CUT ONLY IN WELL VENTILATED AREA

James Hardie™ products contain sand, a source of respirable crystalline silica which is considered by some international authorities to be a cause of cancer from some occupational sources. Breathing excessive amounts of respirable silica dust can also cause a disabling and potentially fatal lung disease called silicosis, and has been linked with other diseases. Some studies suggest smoking may increase these risks. During installation or handling: (1) work in outdoor areas with ample ventilation; (2) minimise dust when cutting by using either 'score and snap' knife, fibre cement shears or, where not feasible, use a HardieBlade™ Saw Blade (or equivalent) and dust-reducing circular saw attached to an appropriate, well maintained, filtered vacuum; (3) warn others in the immediate area to avoid breathing dust; (4) wear a properly-fitted, approved dust mask or respirator (e.g. P1 or P2) in accordance with applicable government regulations and manufacturer instructions to further limit respirable silica exposures. During clean-up use a vacuum and filter, both of which are well maintained and appropriate for capturing fine (respirable) dust. Alternatively, use wet clean-up methods - never dry sweep. For further information, refer to our installation instructions and Safety Data Sheets available at www.jameshardie.com.au. FAILURE TO ADHERE TO OUR WARNINGS, SAFETY DATA SHEETS, AND INSTALLATION INSTRUCTIONS MAY LEAD TO SERIOUS PERSONAL INJURY OR DEATH.

JAMES HARDIE RECOMMENDED SAFE WORKING PRACTICES
CUTTING OUTDOORS <ol style="list-style-type: none">Position cutting station so wind will blow dust away from the user or others in working area.Use one of the following methods based on the required cutting rate:<ul style="list-style-type: none">Best ■ Score and snap ■ Hand guillotine ■ FibreshearBetter ■ Position the cutting station in a well-ventilated area. Use a dust reducing circular saw equipped with HardieBlade™ Saw Blade or comparable fibre cement blade and well maintained vacuum and filter appropriate for capturing fine (respirable) dust.
CUTTING INDOORS <ul style="list-style-type: none">Cut only using score and snap, hand guillotine or fibreshears (manual, electric or pneumatic).Position cutting station in a well-ventilated area
DRILLING / OTHER MACHINING <p>When drilling or machining you should always wear a P1 or P2 dust mask and warn others in the immediate area.</p>
IMPORTANT NOTES <ol style="list-style-type: none">For maximum protection (lowest respirable dust production) James Hardie recommends always using best practice cutting methods where feasible.NEVER use a power saw indoors.ALWAYS use a circular saw blade that carries the HardieBlade™ logo or is of at least comparable performance.NEVER dry sweep - Use wet suppression or appropriate vacuum and filter.NEVER use grinders.ALWAYS follow tool manufacturers' safety recommendations.
DUST MASKS AND RESPIRATORS <p>James Hardie recommends the use of P2 respirators as best practice. As a minimum, an AS/NZS1716 P1 respirator must be used when doing any activity that may create dust. For more extensive guidance and options for selecting respirators for workplaces please refer to Australian/New Zealand Standard 1715:2009 "Selection, Use and Maintenance of Respiratory Protective Equipment".</p> <p>P1 or P2 respirators should be used in conjunction with the above cutting practices to minimise dust exposure.</p> <p>For further information, refer to Safety Data Sheet (SDS) available at www.jameshardie.com.au. If concern still exists about exposure levels or you do not comply with the above practices, you should always consult a qualified industrial hygienist or contact James Hardie for further information.</p>

3 DESIGN / FRAMING

STORAGE AND HANDLING

To avoid damage, all James Hardie™ building products should be stored with edges and corners of the product protected from chipping. James Hardie™ building products must be installed in a dry state and protected from weather during transport and storage. The product must be laid flat under cover on a smooth level surface clear of the ground to avoid exposure to water, moisture, etc.

SCOPE

General

This guide covers the use of the EasyLap™ panel in a residential wall application over a seasoned timber wall frame or a light-gauge steel frame installed in a vertical upright application.

DESIGN

General

All design and construction must comply with the appropriate requirements of the current National Construction Code (NCC) and other applicable regulations and standards.

Responsibility

The specifier or other party responsible for the project must ensure that the details in this specification are appropriate for the intended application and that additional detailing is performed for specific design or any areas that fall outside the scope of this specification.

Slab and footings

The slab and footings on which the building is situated must comply with AS 2870 'Residential slabs and footings – Construction' and the requirements of the National Construction Code (NCC).

Ground clearances

Install James Hardie™ external cladding with a minimum 150mm clearance to the earth on the exterior of the building or in accordance with local building codes if greater than 150mm is required. Maintain a minimum 50mm clearance between James Hardie™ external cladding and roofs, decks, paths, steps and driveways.

Adjacent finished grade must slope away from the building in accordance with local building codes, typically a minimum slope of 50mm minimum over the first metre.

Do not install external cladding such that it may remain in contact with standing water.

NOTE

Greater clearance may be required in order to comply with termite protection provisions, see below for more information.

Termite Protection

The National Construction Code (NCC) specifies the requirements for termite barriers. Where the exposed slab edge is used as part of the termite barrier system, a minimum of 75mm of the exposed slab edge must be visible to permit ready detection of termite entry.

Structural bracing

EasyLap™ panels can be installed to provide wall bracing against lateral forces due to wind. For further information, Ask James Hardie™ on 13 11 03.

Fire rated walls

EasyLap™ panels can achieve fire ratings of 60/60/60 and 90/90/90 when constructed with additional fire rated linings as specified in James Hardie's Fire and Acoustically Rated Design Manual and Construction of Fire and Acoustically Rated Walls Technical Specification. The length of fasteners must be increased for the additional linings.

Moisture Management

It is the responsibility of designer or specifier to identify moisture related risks associated with any particular building design. Wall construction design must effectively manage moisture, accounting for both the interior and exterior environments of the building, particularly in buildings that have a higher risk of wind driven rain penetration or that are artificially heated or cooled.

In addition all wall openings, penetrations, junctions, connections, window sills, heads and jambs must incorporate appropriate flashing and waterproofing. Materials, components and their installation that are used to manage moisture in framed wall construction must, at a minimum, comply with the requirements of relevant standards and the NCC.

Weather Barrier

A suitable water control membrane must be installed under James Hardie™ cladding in accordance with the AS/NZS 4200.2 'Pliable building membranes and underlays – Installation' and NCC requirements.

James Hardie has tested and certified the use of HardieWrap™ weather barrier for climate zones 2-8 within Australia. HardieWrap™ weather barrier is a Class 4 vapour permeable membrane that delivers a triple-shield of protection to help against external weather penetration, internal condensation management and external heat penetration through its safe-glare reflective layer.

If using an alternate product in lieu of HardieWrap™ weather barrier or the project is located in a hot humid area (Climate Zone 1), the designer must ensure that the product is fit for purpose and it has the following classification in accordance with AS/NZS 4200.1:2017 'Pliable building membranes and underlays – Materials':

WEATHER BARRIER CLASSIFICATION		
Climate Zones	Water Barrier	Vapour Permeance
2-8	High	Vapour permeable (Class 3 or 4)
1		Vapour Barrier (Class 1 or 2)

Soft compressible insulation installed between the front of the wall studs and directly behind the external cladding can cause installation issues and is thus not recommended.

Flashing

All wall openings, penetrations, intersections, connections, window sills, heads and jambs must be flashed prior to cladding installation.

FRAMING

General

The EasyLap™ panels are installed vertically to both timber and metal studs.

For Timber framing, the framing width at sheet joints must be a minimum of 45mm and 50mm wide for steel frames. Where the studs at sheet joints are less, provide double 35mm wide studs at sheet joints. Ensure double studs are well fastened together and flush at the outside face.

All intermediate support studs must be a minimum of 70 x 35mm for timber and 64 x 35mm deep for metal framing.

Maximum stud spacings for EasyLap™ panels for wind load classifications of AS 4055 'Wind Loads for Housing' are given in Table 1.

TABLE 1

MAXIMUM STUD & FASTENER SPACING FOR EASYLAP™ PANEL CLADDING IN AS 4055 WIND CLASSIFICATIONS							
Non-Cyclonic	Cyclonic	General Areas of Walls (mm)			Within 1200mm of Building Edges (mm)		
		Stud Spacing	Fastener Spacing (Except Brads)	ND50mm Brads	Stud Spacing	Fastener Spacing (Except Brads)	ND50mm Brads
N1, N2, N3	C1	600	200	125	600	200	125
N4	C2	600	200		450	150	
N5	C3	450	200		300	150	
N6	C4	450	150		300	125	

NOTE: When using brad nails:

- Do not over drive the fasteners into the sheet.
- Ensure that brad nails are not used in high wind areas, see Table 1.
- Where twisting/warping of the top or bottom timber plates may occur, consideration should be given to either using fibre cement nails or closing up brad nail spacings at the plates.

Timber

Use of timber framing must be in accordance with AS 1684 - 'Residential timber-framed construction' and the framing manufacturer's specifications.

Use only seasoned timber. Unseasoned timber must not be used because it is prone to shrinkage and can cause sheets and frames to move.

'Timber used for house construction must have the level of durability appropriate for the relevant climate and expected service life and conditions including exposure to insect attacks or to moisture, which could cause decay.' Reference AS 1684.2

'Residential timber-framed construction'.

Steel

Use of steel framing must be in accordance with NASH standard for Residential and Low-Rise Steel Framing **Part 1: Design** Criteria and the framing manufactures specifications. Framing members must have a base metal thickness (BMT) between 0.55 to 1.6mm. The steel framing must have the appropriate level of durability required to prevent corrosion.

Thermal Break

For steel frames, the Building Code of Australia sections J1.5 and 3.12.1 volumes 1 and 2 respectively, state for both residential and commercial buildings a thermal break with an R 0.2m² K/W must be installed behind external cladding where the cladding and internal lining make direct contact with the same steel frame. For information relating to the suitability of James Hardie's HardieBreak™ thermal strip, refer to the HardieBreak™ Installation Guide at www.jameshardie.com.au

Tolerances

Ensure frame is square and work from a central datum line. Frames must be straight and true to provide a flush face to receive the sheeting.

A suggested maximum tolerance of between 3mm and 4mm in any 3000mm length of frame will give best results. EasyLap™ panels will not straighten excessively warped or distorted frames and any warping may still be visible after the cladding is applied.



FIGURE 1 FRAME STRAIGHTNESS

4 PREPARATION AND FASTENERS

PREPARATION

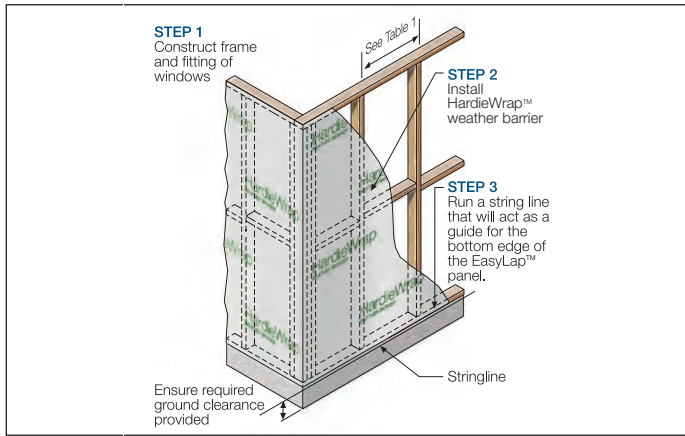

FIGURE 2 PREPARATION

NOTES

Generally, external and internal corners have additional framing requirements. Refer to the external and internal corner details for more information.

FASTENERS

General

All nails must be driven flush. Screws may be driven flush or countersunk 1.5mm and filled over flush with Megapoxy P1

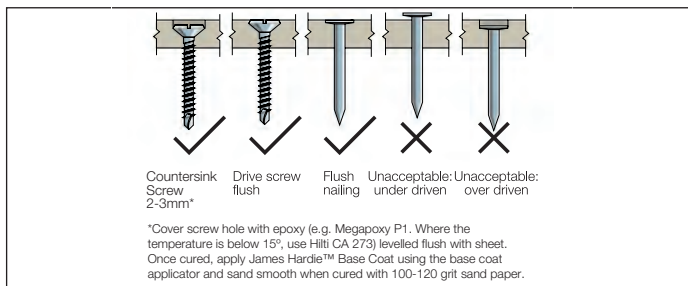

FIGURE 3 NAIL FASTENER DEPTH

Fasteners should be screwed as close as possible to the stud corners to avoid deflection of the stud flange, see Figure 4.

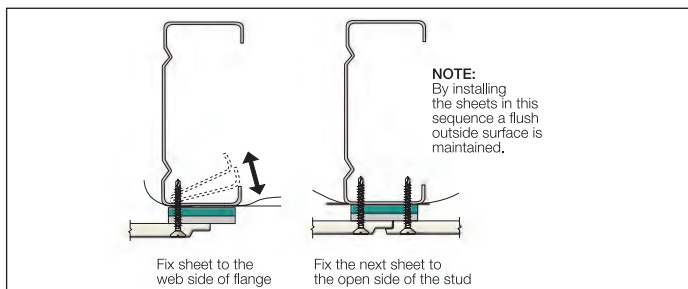

FIGURE 4 SCREW FASTENING

Fastener Durability (Including coastal areas)

Fasteners must have the appropriate level of durability required for the intended project. In areas within 1km of a coastal area, areas subject to salt spray and other corrosive environments, class 4 fasteners must be used. All other areas require a minimum class 3 fastener. Fasteners must be fully compatible with all other materials that they are in contact with to ensure the durability and integrity of the assembly. Contact fastener manufacturers for more information.

Timber frames

For timber frames, use a 2.8 x 30mm galvanised fibre cement nail. In wind classifications N1, N2 and N3 the ND 50mm Stainless nail may be used, see Table 1.

Steel frames

For steel framing thickness of 0.5mm – 1.6mm BMT – use 41mm HardieDrive™ screws. Refer to thermal break statement on page 5.

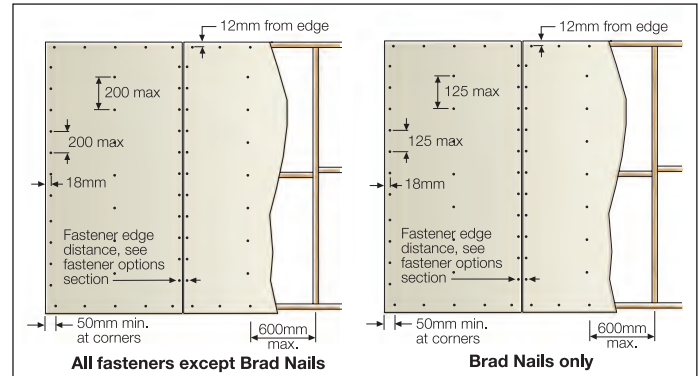

FIGURE 5 SHEET FASTENING SPACING (TWO METHODS)

SHEET INSTALLATION

NOTE

You must ensure the product is of acceptable quality prior to installation, see Important Note 3 on page 2.

EasyLap™ panels must be installed vertically with all sheet edges fully supported. Centre of sheet joints must coincide with the centre line of the framing member and all sheets are installed in one direction.

At every vertical sheet joint, a 50mm foam back sealing tape is applied under the shiplap vertical joint and in front of the HardieWrap™ weather barrier, see Figure 6.

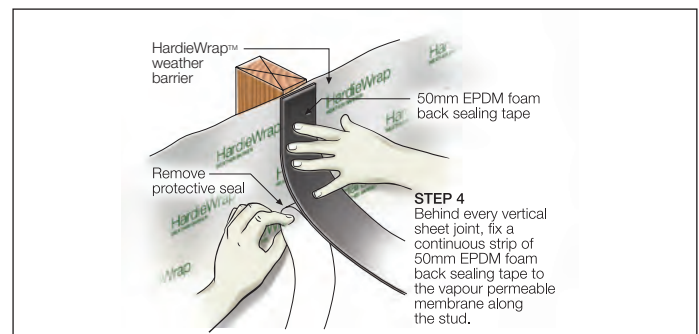

FIGURE 6 APPLY FOAM TAPE AT SHEET JOINTS

To ensure the fasteners fixed at the edge of the sheet has adequate edge distance into the stud, position the underlap sheet on every stud 3mm beyond the centre of the stud.

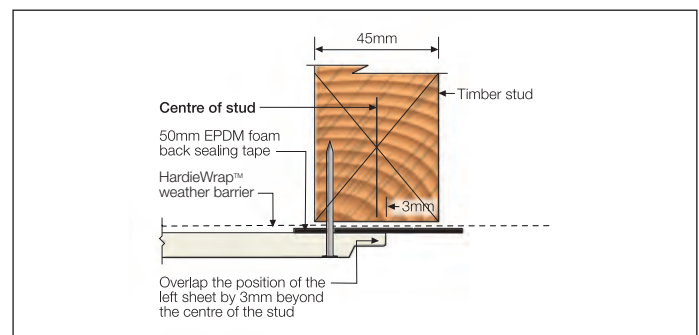

FIGURE 7 SHEET EDGE POSITION ON STUD

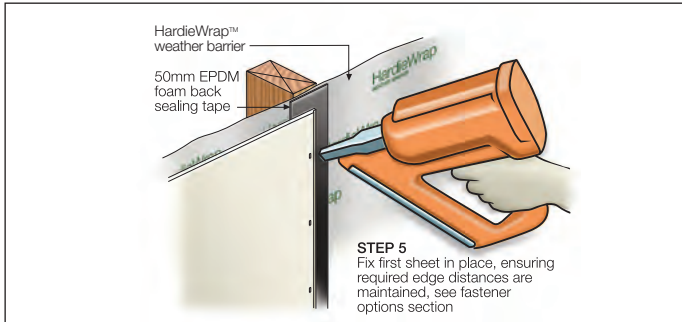

FIGURE 8 FIX FIRST SHEET

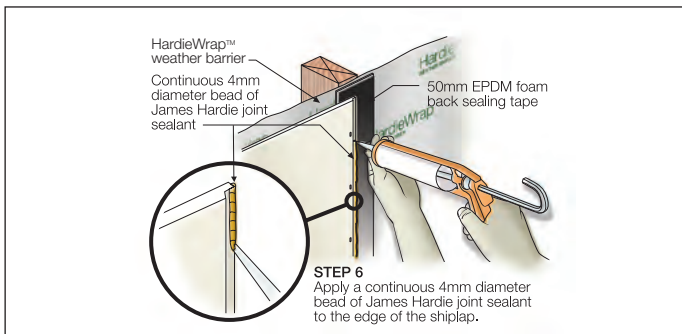

FIGURE 9 APPLY JOINT SEALANT

NOTE

1. Notch tip of sealant nozzle to act as a guide down the sheet edge.
2. Alternatively, it is acceptable to apply sealant to the overlapping sheet edge before installation.

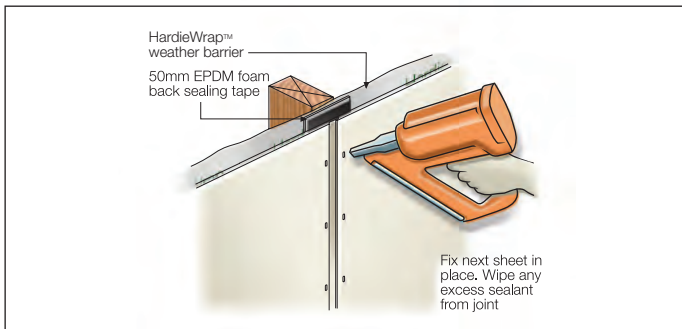

FIGURE 10 FIX NEXT SHEET

NOTE

After overlapping sheet is installed, inspect joint for gaps and fill with additional sealant.

FASTENER OPTIONS

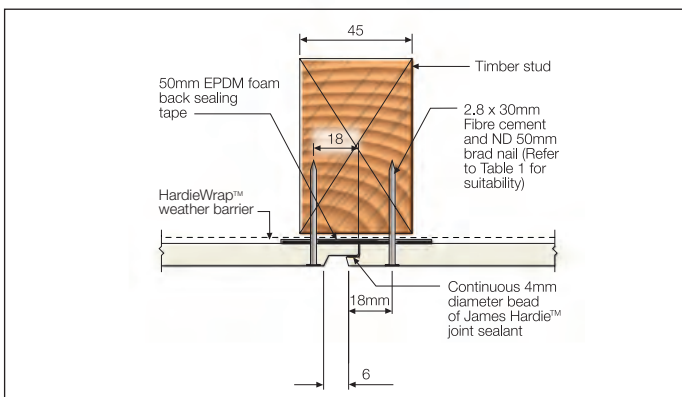

FIGURE 11 FIBRE CEMENT AND BRAD NAIL FIXING

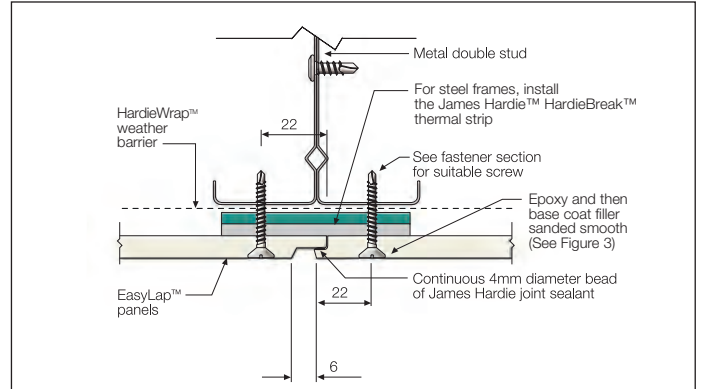

FIGURE 12 SHEET JOINT ON STEEL - FLUSH SCREW OPTION

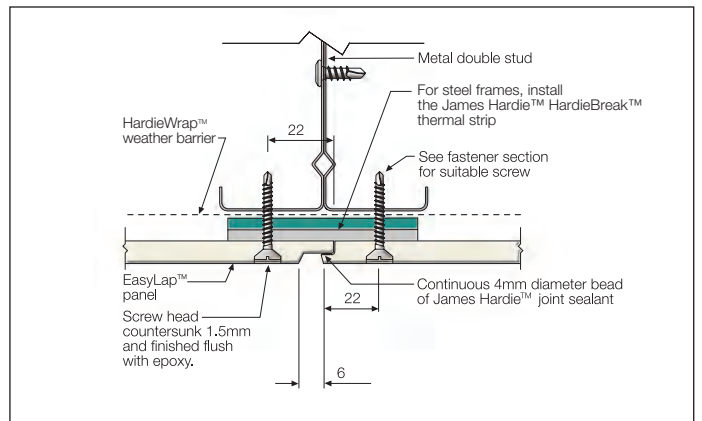

FIGURE 13 COUNTERSUNK SCREW OPTION

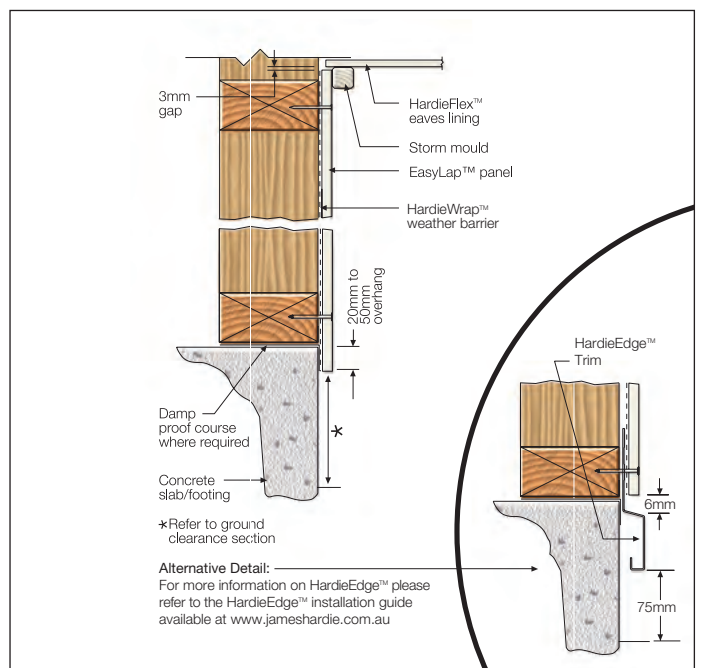

FIGURE 14 SLAB/EAVE JUNCTION DETAIL

5 DETAILS

CAD details are available for download at ACCEL™ www.accel.com.au.

WINDOW DETAILS

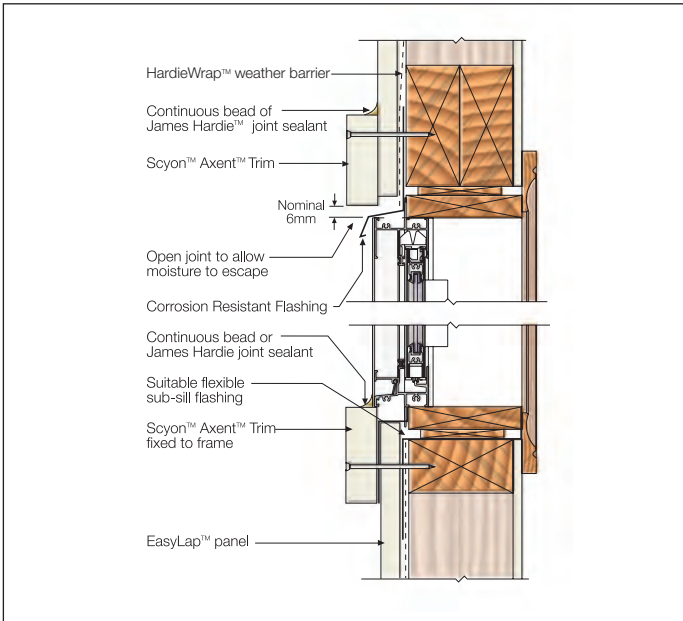

FIGURE 15 WINDOW HEAD AND SILL - TRIM

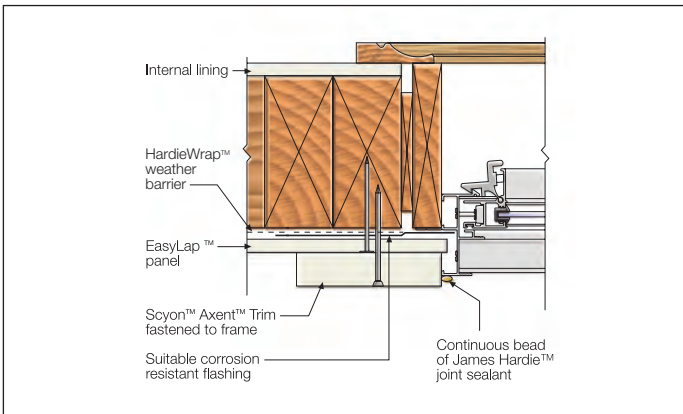

FIGURE 16 WINDOW JAMB - TRIM

EXTERNAL CORNER DETAILS

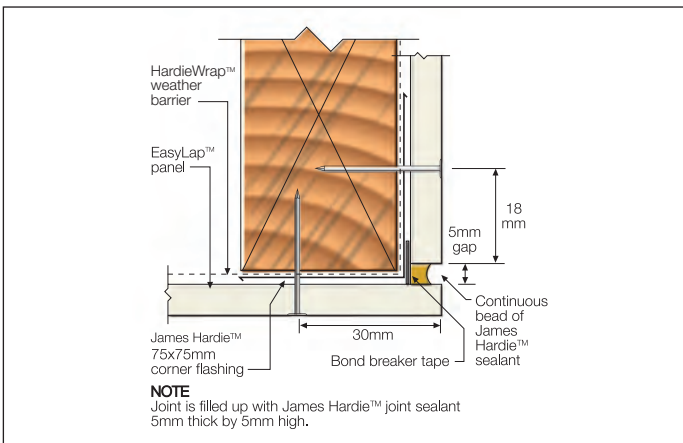

FIGURE 17 SEALANT FILL OPTION

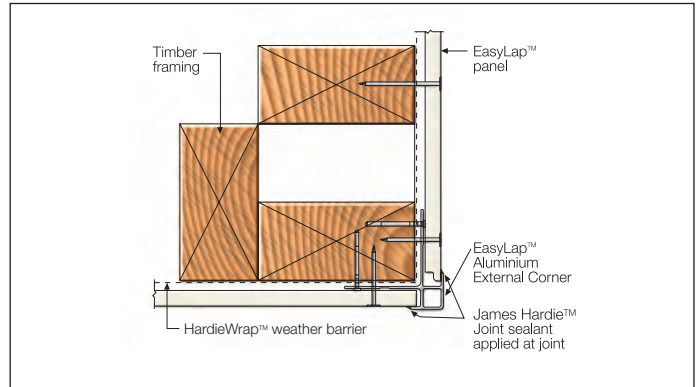

FIGURE 18 ALUMINIUM BOX CORNER OPTION

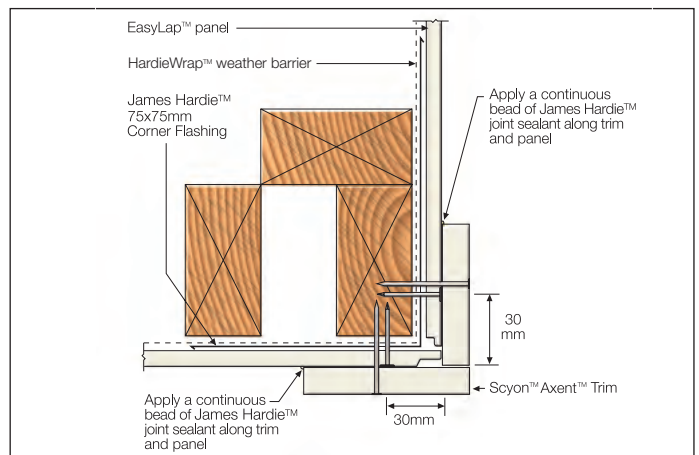

FIGURE 19 TRIM CORNER OPTION

INTERNAL CORNER DETAILS

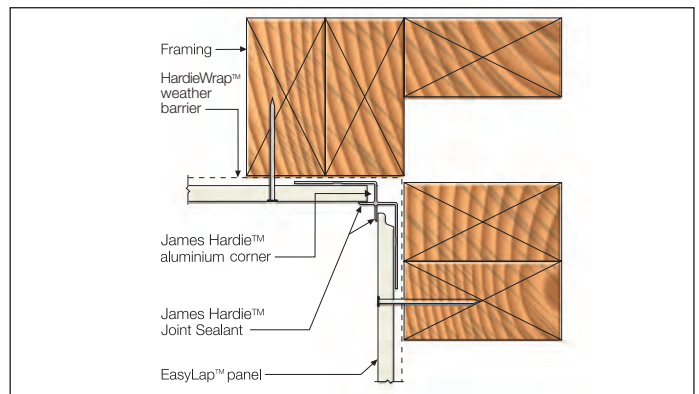

FIGURE 20 ALUMINIUM CORNER DETAIL

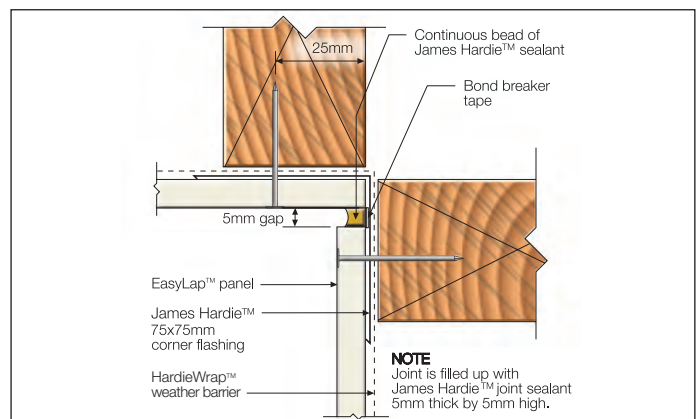

FIGURE 21 SEALANT FILL OPTION

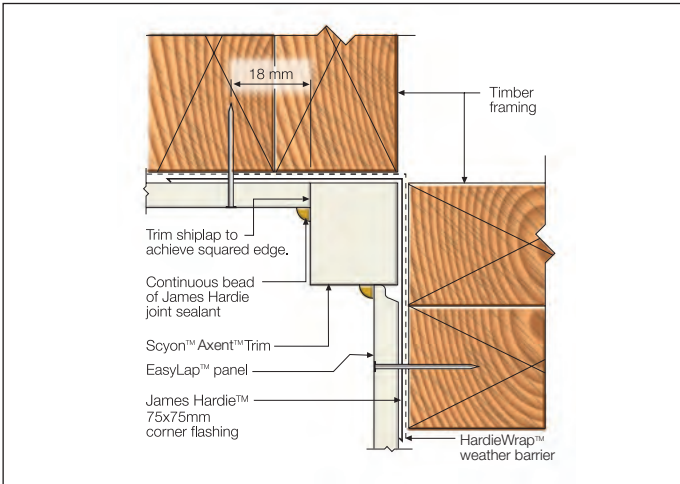

FIGURE 22 TRIM CORNER OPTION

JUNCTION DETAILS

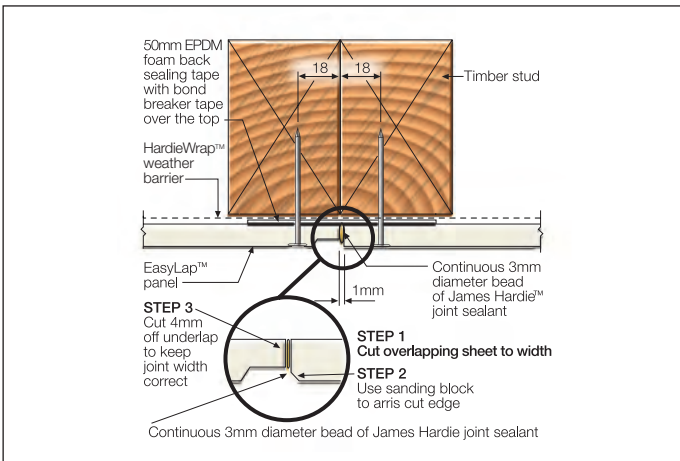

FIGURE 23 VERTICAL BUTT JOINT

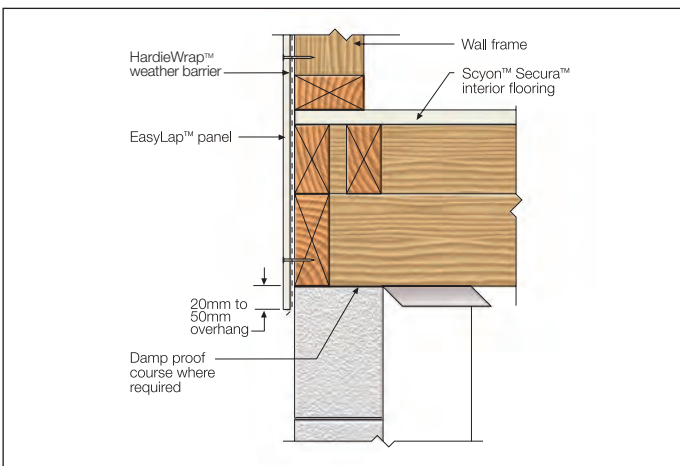

FIGURE 24 LOWER FLOOR JUNCTION

The EasyLap™ panels must not continue over a floor junction or where excessive movement or creep will occur, see Figures 25 and 26.

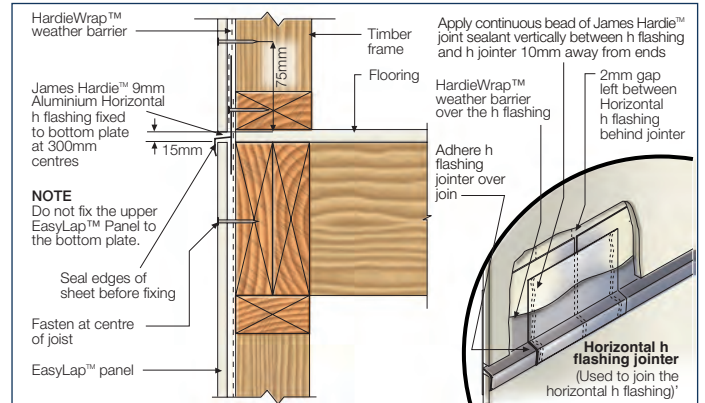

FIGURE 25 UPPER FLOOR JUNCTION

NOTE: Join the James Hardie™ 9mm Aluminium Horizontal h flashing on intermediate studs and not off stud or behind sheet joints.

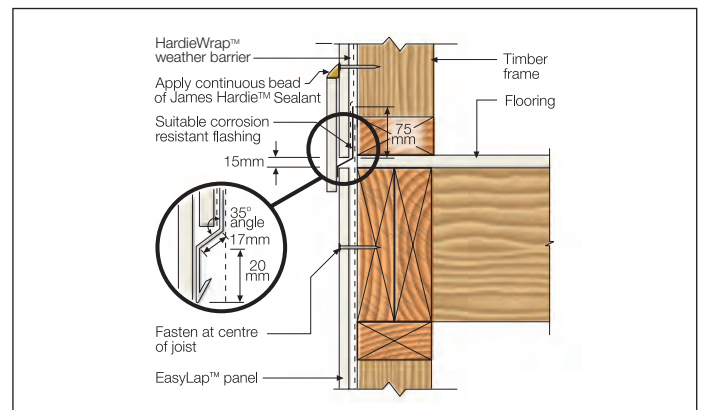

FIGURE 26 UPPER FLOOR JUNCTION OPTION 2

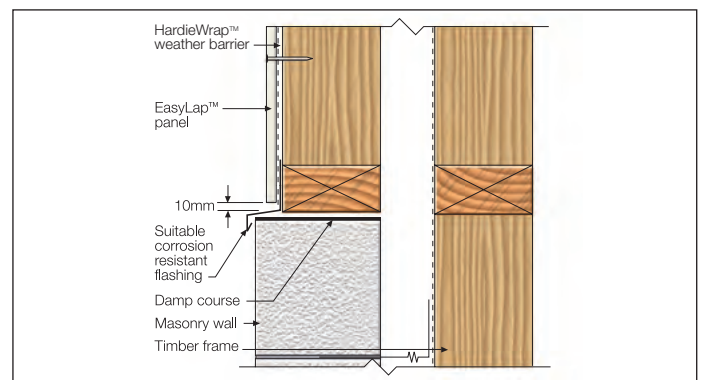

FIGURE 27 HORIZONTAL JUNCTION 1

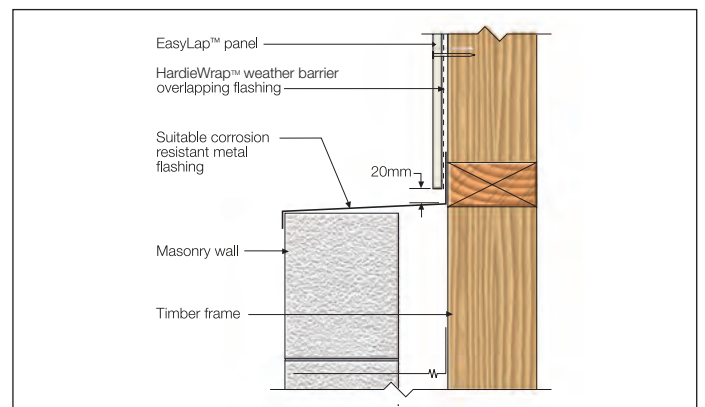

FIGURE 28 HORIZONTAL JUNCTION 2

6 FINISHES AND MAINTENANCE

FINISHING

Sealant

Application and use of sealants must comply with manufacturer's instructions. Sealants, if coated, must be compatible with the paint system.

Painting

EasyLap™ panels are ready for texture. All sheets must be dry before painting.

Refer to the project specification for paint requirements. EasyLap™ panels must be finished with texture paint within 3 months of being fixed. In areas within 1km of a coastal area or corrosive environment, the EasyLap™ panels must be painted immediately after fixing sheets to minimise contamination build up on the heads of the fasteners, as it may lead to fastener corrosion.

James Hardie™ recommends the application of a roll on exterior texture coat system over the panels in accordance with the paint manufacturer's specifications. Some environments require special coatings including coastal areas. Painting selection and specifications are dependant on the paint chosen. Refer to Dulux, Taubmans or Wattyl for further information, product suitability, specifications, maintenance and details of their warranty.

Staining

Stains containing linseed oil are specifically designed for wood and may not be suitable for James Hardie™ cladding products, primed or un-primed.

Semi-transparent stains can vary in uniformity of appearance depending on method of application and conditions and will require a high level of skill and craftsmanship to achieve a uniform appearance. Clear coats have not proven durable in exterior exposure and James Hardie™ considers them a maintenance item that may require application of a refurbishing sealer at regular intervals. James Hardie™ does not warrant the appearance or durability of semi-transparent stains and clear coats.

MAINTENANCE

The extent and nature of maintenance will depend on the geographical location and exposure of the building. As a guide, it is recommended that basic normal maintenance tasks shall include but not be limited to:

- Washing down exterior surfaces every 6-12 months*
- Periodic inspections should be made to ensure fasteners are adequately securing the sheets to framing.
- Re-applying of exterior protective finishes*
- Maintaining the exterior envelope and connections including joints, penetrations, flashings and sealants that may provide a means of moisture entry beyond the exterior cladding.
- Cleaning out gutters, blocked pipes and overflows as required.
- Pruning back vegetation that is close to or touching the building.

*Refer to your paint manufacturer for washing down and recoating requirements related to paint performance.

7 PRODUCT INFORMATION

PRODUCT INFORMATION

Material

The basic composition of James Hardie™ building products is Portland cement, ground sand, cellulose fibre, water and proprietary additives.

James Hardie™ building products are manufactured AS/NZS 2908.2 'Cellulose-Cement Products-Flat Sheet'. These are also compliant with equivalent standard ISO 8336 'Fibre-cement flat sheets - Product specification and test methods'. For product classification refer to the relevant Physical Properties Data Sheet.

Durability

Resistance to moisture/rotting

EasyLap™ panels have demonstrated resistance to permanent moisture induced deterioration (rotting) by passing the following tests in accordance with AS/NZS 2908.2:

- Water permeability (Clause 8.2.2)
- Heat rain (Clause 6.5)
- Warm water (Clause 8.2.4)
- Soak dry (Clause 8.2.5)

Resistance to fire

The EasyLap™ panels is suitable where non-combustible materials are required in accordance with C1.9 of the Building Code of Australia.

James Hardie™ building products have been tested by CSIRO in accordance with AS/NZS 3837 and are classified as conforming to Group 1 material (highest and best result possible), with an average specific extinction area far lower than the permissible 250m²/kg, as referenced in Specification C1.10a of the National Construction Code (NCC).

Resistance to termite attack

Based on testing completed by CSIRO Division of Forest Products and Ensis Australia James Hardie™ building products have demonstrated resistance to termite attack.

Alpine regions

In regions subject to freeze/thaw conditions, all James Hardie™ fibre cement external cladding must be installed and painted in the warmer months of the year where the temperature does not create freeze and thaw conditions or paint issues. The cladding must be painted immediately after installation. In addition, fibre cement cladding must not be in direct contact with snow and/or ice build up for extended periods, e.g. external walls in alpine regions subject to snow drifts over winter.

Furthermore, a reputable paint manufacturer must be consulted in regards to a suitable product, specifications and warranty. The paint application must not be carried out if the air temperature or the substrate temperature is outside the paint manufacturer's recommendation including the specified drying temperature range

James Hardie™ external cladding products are tested for resistance to frost in accordance with AS/NZS 2908.2 Clause 8.2.3.

**For inspiration,
specification details
& downloads visit...**

www.adxarchitectural.com.au



(08) 8292 5000 solutions@adxdepot.com.au

For more information & to buy online visit
www.adxdepot.com.au